

RSG EDELSTAHL®
Rost
frei

Solingen

ROSTFREI-SCHNEIDWERKZEUGE GMBH

Lieferprogramm Laborgeräte



Chirurgo

	Seite / Page
Inhalt	
Content	
Zangen <i>Tongs</i>	3
Rührer für Rührwerke <i>Stirrers</i>	4
Pinzetten <i>Tweezers / forceps</i>	5-7
Spatel / Mikrospatel / Spatel-Sets <i>Spatulas / micro spatulas / spatula sets</i>	7-11
Löffel / Löffelspatel / Drigalski-Spatel <i>Spoons / spoons with spatulas / Drigalski spatulas</i>	10-13
Apothekerspatel / Schnitffänger <i>Chemists spatulas</i>	13-14
Stativplatten <i>Retorts</i>	14
Präparier- / Mikroskopierbestecke / Spatel-Sets <i>Microscopy sets / dissecting sets / spatula sets</i>	15-17
Stativstäbe / DreifüÙe / Klemmen / Stativringe <i>Support rods / tripods / clamps / support rings</i>	18-19
Drahtnetze / Quarzdreiecke / Rasierer <i>Wire gauzes / triangles / razors</i>	20
Skalpelle / Nadelhalter / Präpariernadeln <i>Scalpels / needleholders / dissecting needles</i>	21
Kleinmaterial / Nadeln / AbstrichöÙen <i>Small articles / needles / loops</i>	22
Schraub- und Quetschhähne / Skalpellhalter <i>Tube clamps / scalpelholders</i>	23
Scheren <i>Scissors</i>	24-25
Drahtkörbe / Hohlwaren / Schaufeln <i>Wire baskets / vessels, beakers, bowls / scoops</i>	25-28
Sicherheitsinstrumente <i>Safety instruments</i>	28
Messer <i>Knives</i>	29
Brenner / Reagenzglasgestelle <i>Burners / racks</i>	30



Alle Artikel aus Edelstahl Remanit 4301 sind antimagnetisch. Technische Änderungen vorbehalten.

All articles made of stainless steel 18/10 are antimagnetic. Technical modifications are subject to change without notice.

Tiegelzangen, Remanit 4301, doppelt gebogen, Spitzen geschliffen, elektrolytisch poliert

Crucible tongs, double curved, tips polished, electropolished, 18/10

Länge / length mm	200	220	250	300	400	500	600
	42.200	42.220	42.250	42.300	42.400	42.500	42.600

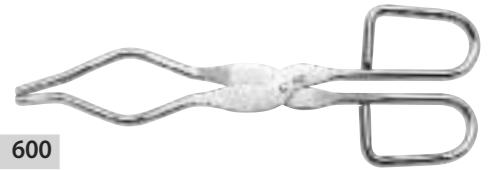

Tiegelzangen, Remanit 4301, doppelt gebogen, Spitzen ungeschliffen

Crucible tongs, double curved, tips unpolished, 18/10

Länge / length mm	200	220	250	300
Elektrolytisch poliert / electropolished	40.200	40.220	40.250	40.300
Unpoliert / unpolished	840.200	840.220	840.250	840.300



Tiegelzangen, Remanit 4301, Scherengang mit Schraube, elektrolytisch poliert

Crucible tongs, "scissors", electropolished, 18/10

Länge / length mm	200	220	250	300
Doppelt gebogen / double curved	81.200	81.220	81.250	81.300



Kolbenzange, Remanit 4301, Korkeinlagen für Durchmesser 15-60 mm, elektrolytisch poliert

Beaker tong, cork lined, for diameter 15-60 mm, electropolished, 18/10

Länge / length mm	230
	43.230



Becherzange, Remanit 4301, für Durchmesser 60-150 mm, Backen mit Keramikfaden umwickelt

Beaker tong, ceramic string protection, for diameter 60-150 mm, 18/10

Länge / length mm	300
	43.330



Becherzangen, Remanit 4301, Korkeinlagen, elektrolytisch poliert

Beaker tongs, cork lined, electropolished, 18/10

Länge / length mm	200	220	250	300
Durchmesser / diameter mm	30	40	50	60
	43.200	43.220	43.250	43.300



Becherzange, starke Ausführung, Remanit 4301, Gummiüberzug

Beaker tong, strong version, rubber protection, 18/10

Länge / length mm	250
	43.251

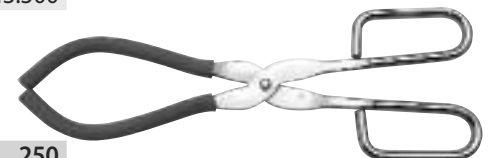

Universal-Becherzange, Remanit 4301, Gummiüberzug, zusätzliche Ausbuchtungen an der Spitze für kleine Kolben, Becher etc.

All purpose beaker tong, rubber protection, with 2 diameters, 18/10

Länge / length mm	290
	43.290

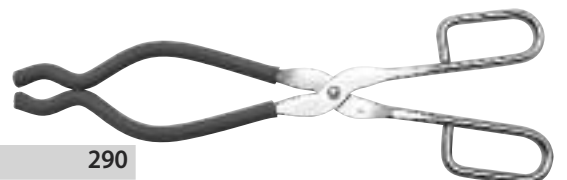

**Propeller-Rührer, 3 Flügel, Remanit 4301,
Stab mit aufgeschraubtem Rührkopf**

Stirrers with shaft, propeller, 3 paddles, 18/10



Rührflächen Ø mm surface diameter mm	Stablänge / Ø mm		shaft length / diameter mm		Rührköpfe ohne Stab stirrers without shaft
	300 / Ø 6	320 / Ø 8	550 / Ø 8		
50	60.050	68.050			660.050
70	60.070	68.070			660.070
100	60.100	68.100			660.100
140		60.139	60.140		660.140

**Propeller-Rührer, 4 Flügel, Remanit 4301,
Stab mit aufgeschraubtem Rührkopf**

Stirrers with shaft, propeller, 4 paddles, 18/10



Rührflächen Ø mm surface diameter mm	Stablänge / Ø mm		shaft length / diameter mm		Rührköpfe ohne Stab stirrers without shaft
	150 / Ø 6	350 / Ø 6	320 / Ø 8	550 / Ø 8	
50	60.550	60.551			660.550
100		60.500	60.503	60.505	660.500

**Rührer, 4 Flügel, Remanit 4301,
Stab mit aufgeschraubtem Rührkopf**

Stirrers with shaft, 4 paddles, 18/10



Rührflächen Ø mm surface diameter mm	Stablänge / Ø mm		shaft length / diameter mm		Rührköpfe ohne Stab stirrers without shaft
	300 / Ø 6	320 / Ø 8			
50	60.450				660.450
70	60.470				660.470
100			60.400		660.400

**Dispergier-Rührer, Remanit 4301,
Stab mit aufgeschraubtem Rührkopf**

Stirrer with shaft, circular saw type, 18/10



Rührfläche Ø mm surface diameter mm	Stablänge / Ø mm	shaft length / diameter mm	Rührkopf ohne Stab stirrer without shaft
80		550 / Ø 8	660.888

**Rühr-Stäbe, Remanit 4301,
jeder Stab passt zu allen Rührköpfen, Gewindestutzen M 5**

Shafts for all stirrers, M5 threaded connector end, 18/10



Durchmesser mm diameter mm	Länge mm / length mm						
	150	300	320	350	420	550	1000
6	606.150	606.300		606.350	606.420		
7			607.320	607.350	607.420	607.550	
8			608.320		608.420	608.550	
10			610.320			610.550	610.001

Stumpfe Pinzetten, Remanit 4301

Blunt tweezers, 18/10



Länge / length mm	105	115	130	145	160	200	250	300
1. Qualität / quality finish	11.105	11.115	11.130	11.145	11.160	11.200	11.250	11.300
Normal-Ausführung / normal finish	611.105	611.115	611.130	611.145	611.160	611.200	611.250	611.300
Teflon-beschichtet / Teflon-coated	411.105	411.115	411.130	411.145	411.160	411.200		

Gebogene stumpfe Pinzetten, Remanit 4301

Curved blunt tweezers, 18/10



Länge / length mm	115	130	145	160	200
1. Qualität / quality finish	12.115	12.130	12.145	12.160	12.200
Normal-Ausführung / normal finish	612.115	612.130	612.145	612.160	612.200

Spitze Pinzetten, Remanit 4301

Pointed tweezers, 18/10



Länge / length mm	105	115	130	145	160	200
1. Qualität / quality finish	13.105	13.115	13.130	13.145	13.160	13.200
Normal-Ausführung / normal finish	613.105	613.115	613.130	613.145	613.160	613.200
Teflon-beschichtet / Teflon-coated	413.105	413.115	413.130	413.145	413.160	413.200

Gebogene spitze Pinzetten, Remanit 4301

Curved pointed tweezers, 18/10



Länge / length mm	105	115	130	145	160	200
1. Qualität / quality finish	14.105	14.115	14.130	14.145	14.160	14.200
Normal-Ausführung / normal finish	614.105	614.115	614.130	614.145	614.160	614.200
Teflon-beschichtet / Teflon-coated	414.105	414.115	414.130	414.145	414.160	414.200

Spitze Pinzetten mit Führungsstift, feine Ausführung, Remanit 4301

Pointed tweezers with guide pin, fine model, 18/10



Länge / length mm	105	115	130	145	160	200
gerade / straight	311.105	311.115	311.130	311.145	311.160	311.200
gebogen / curved	312.105	312.115	312.130	312.145	312.160	312.200

Deckglas-Pinzetten nach Kühne, gerade, Remanit 4301

Cover glass tweezers, straight, 18/10

Länge / length mm	115
1. Qualität / <i>quality finish</i>	15.104
Normal-Ausführung / <i>normal finish</i>	615.104
Teflon-beschichtet / <i>Teflon-coated</i>	415.104



Deckglas-Pinzetten nach Kühne, gebogen, Remanit 4301

Cover glass tweezers, curved, 18/10

Länge / length mm	115	130	145
1. Qualität / <i>quality finish</i>	15.105	15.130	15.145
Normal-Ausführung / <i>normal finish</i>	615.105		
Teflon-beschichtet / <i>Teflon-coated</i>	415.105		



Spezial-Pinzetten, außerordentlich feine, präzise geschliffene Spitzen, Remanit 4301

Special tweezers, very fine, precisely polished tips, 18/10

Länge / length mm	110	120
	116.110	116.137



Turmspitze/tower-tip 110



gebogen/curved 120

Spezial-Pinzetten, außerordentlich feine, präzise geschliffene Spitzen, Remanit 4301

Special tweezers, very fine, precisely polished tips, 18/10

Länge / length mm	120	130
	116.120	116.130



Teflon-Pinzetten, Remanit 4301

Teflon tweezers, 18/10

Länge / length mm	110	130
Teflon-beschichtet / <i>Teflon-coated</i>	416.110	416.130



416.110



416.130

Federstahl-Pinzetten

Lightmetal tweezers

Länge / length mm	125
stumpf / <i>blunt</i>	111.010
spitz / <i>pointed</i>	113.010



111.010



113.010

Verschiedene Pinzetten mit Spitzen aus Keramik und Kunststoffgriff

Different tweezers with ceramic tips and handles made of polyacetal

Länge / length mm	130
Innen gezahnt / serrated	10.020
Innen glatt / smooth	10.030
Innen glatt / smooth	10.040



Keramik-Pinzetten, massiv, stumpf

Solid ceramic tweezers, blunt

Länge / length mm	125
Spitze 1 mm breit, glatt / tip 1 mm wide, smooth	10.050
Spitze 1 mm breit, gezahnt / tip 1 mm wide, serrated	10.060

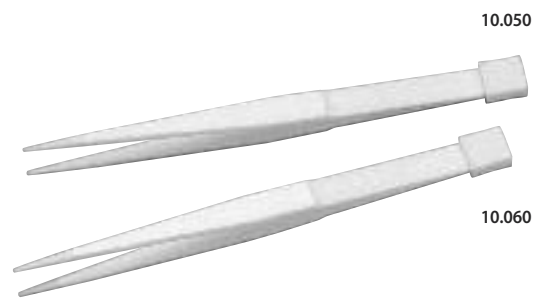

Keramik-Pinzetten, massiv, spitz

Solid ceramic tweezers, pointed

Länge / length mm	120	125
Sehr spitz, glatt / very pointed, smooth	10.070	
Spitz gebogen, glatt / pointed curved, smooth	10.080	

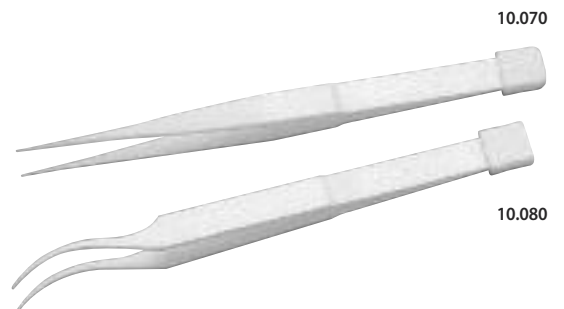

Mikrolöffel / Mikro-Pulverspatel / Mikrospatel (gerade / rund), 6-kant-Griff, Remanit 4301

Micro spoon / micro powder spatula / micro spatula (straight / round), hexagon handle, 18/10

Länge / length mm	150	150	150	150
Breite / width mm	2	3	4	5
Mikrolöffel				533.005
Mikro-Pulverspatel		532.003	532.004	
Mikrospatel gerade		531.003	531.004	
Mikrospatel rund	530.002	530.003		



Doppelspatel, schmale Form, Remanit 4301

Double spatula, narrow version, 18/10

Länge / length mm	130	150	185	210	250	300	350	400	500
Breite / width mm	9	9	9	11	11	16	16	20	20
flexibel / flexible	30.130	30.150	30.185	30.210	30.250				
starr / stiff	830.130	830.150	830.185	830.210	830.250	830.300	830.350	830.400	830.500



Knopfspatel, Remanit 4301, mit Kunststoffknopf

Spatulas with plastic knob, 18/10



Länge / length mm	150	200	210	250	300	400	500
schmale Form / standard	90.150		90.210	90.250	90.300		
breite Form / wide version	992.150	992.200		992.250	992.300	992.400	992.500

Doppelspatel, breite Form, Remanit 4301

Double spatulas, wide version, 18/10



Länge / length mm	150	200	250	300	400	500
Breite / width mm	20	20	20	30	30	30
	92.150	92.200	92.250	92.300	92.400	92.500

Doppelspatel, einseitig aufgebogen, 9 mm breit, Remanit 4301

Double spatulas with one curved end, 9 mm wide, 18/10



Länge / length mm	150	185	210	230
	38.150	38.185	38.210	38.230

Spatel, flache Löffel, ca. 10 mm breit, Remanit 4301

Spatulas, flat spoons, approx. 10 mm wide, 18/10

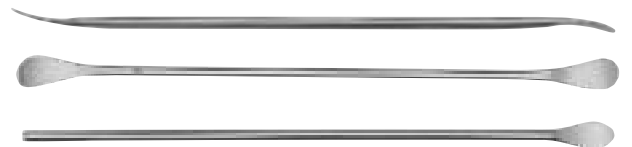

Länge / length mm	180	210
doppelt / double	38.180	38.215
einfach / single	98.180	98.215

Mikro-Doppelspatel, sehr flexibel, Remanit 4301

Micro double spatulas, very flexible blades, 18/10



Breite / width mm	Länge / length mm				
	100	130	150	185	210
2	32.100	32.130	32.150		
3	33.100	33.130	33.150	33.185	
4	34.100	34.130	34.150	34.185	34.210
5	35.100	35.130	35.150	35.185	35.210
6		36.130	36.150	36.185	36.210

Mikro-Pulverspatel, sehr flexibel, Remanit 4301

Micro powder spatulas, very flexible, 18/10



Breite / width mm	Länge / length mm			
	130	150	185	210
3		373.150		373.210
4	374.130	374.150	374.185	
5		375.150		
6	376.130	376.150	376.185	376.210
7		377.150		

Mikro-Doppelspatel, ein Ende löffelförmig, Remanit 4301

Micro double spatulas with one spoon end, 18/10



Länge / length mm	150	185
Breite / width mm	5	5
	395.150	395.185

Mikro-Doppelspatel, beide Enden löffelförmig, Remanit 4301

Micro double spatulas with two spoon ends, 18/10



Breite / width mm	Länge / length mm				
	130	150	185	210	250
5	385.130	385.150	385.185	385.210	
7		387.150	387.185		387.250

Mikrospatel, löffelförmig gebogen, Remanit 4301

Micro spatulas with one bent spoon, 18/10



Länge / length mm	130	150	185	210
Breite / width mm	5	5	5	5
	985.130	985.150	985.185	985.210

Mikro-Löffelspatel, Remanit 4301

Micro spoon spatulas, 18/10



Breite / width mm	Länge / length mm					
	100	150	185	210	300	400
5	25.100	25.150	25.185	25.210	25.300	25.400
7		627.150	627.185	627.210		

Mikro-Doppelspatel, 7 mm breit, einseitig konisch, Remanit 4301

Micro double spatulas with one conical end, 7 mm wide, 18/10



Länge / length mm	140	160	210
	39.140	39.160	39.210

Mikrospatel, mit Kunststoffgriff, Remanit 4301

Micro spatulas with plastic handle, 18/10



Länge / length mm	150	150	150
Breite / width mm	3	4	5
Blatt vorne rund / round end	87.033		87.035
Pulverspatel / powder spatula	87.373	87.374	87.375
Löffelförmig gebogen / bent spoon		87.984	

87.033, 87.035

87.373, 87.374, 87.375

87.984

Mikro-Löffel, mit Kunststoffgriff, Remanit 4301

Micro spoon with plastic handle, 18/10



Länge / length mm	150
Breite / width mm	5
	87.025

Mikrospatel Set, mit Kunststoffgriffen, Remanit 4301

Micro spatula set with plastic handle, 18/10



Inhalt	Contents
Je 1 Spatel 3, 4, 5, 6 mm Breite	Spatulas 3, 4, 5, 6 mm width
Länge / length mm	150
Set mit 4 Stück / set with 4 pcs.	87.000

Mikro-Pulverspatel Set

Micro powder spatula



Inhalt	Contents
Je 1 Pulverspatel 3, 4, 5, 6 mm Breite	Powder spatulas 3, 4, 5, 6 mm width
Länge / length mm	150
Set mit 4 Stück / set with 4 pcs.	87.300

Mikro-Doppelspatel, starre Ausführung, Remanit 4301

Micro double spatulas, stiff version, 18/10



Breite / width mm	Länge / length mm				
	100	130	150	185	210
3	833.100	833.130	833.150	833.185	
5	835.100	835.130	835.150	835.185	835.210
6		836.130	836.150	836.185	836.210

Klappspatel im Taschenmesserformat, super flexibel, mit geschliffenen Schalen

Pocket spatula, foldable spatula, very flexible with polished handle



	000.111
--	---------

Zäh-Spatel, Remanit 4301

Micro spatula with one square end, 18/10



Länge / length mm	150
Breite / width mm	7
	316.150

Drigalski-Spatel, Remanit 4301
alternativ als Rührer verwendbar

Drigalski spatulas, can also be used as stirrers, 18/10



Länge / length mm	165	165
Breite / width mm	30	40
	353.165	354.165

Pulverspatel, Remanit 4301

Powder spatulas, 18/10



Länge / length mm	130	150	185	210
Breite / width mm	9	9	9	9
	37.130	37.150	37.185	37.210

Wäge-Schäufelchen, Remanit 4301

Weighing spoon, trough type end, 18/10



Länge / length mm	170
	29.170

Löffelspatel, Remanit 4301

Spatel: 9 mm, Löffel: 19 mm breit

Spoon and spatula, rod handle, 18/10
spoon: 19 mm, spatula: 9 mm



Länge / length mm	235
	38.235

Doppellöffel, Remanit 4301

Double spoon, 18/10



Länge / length mm	190
	328.190

Löffelspatel, Remanit 4301

Spoon and spatula, standard, 18/10



Länge / length mm	120	150	180	210	250	300
	21.120	21.150	21.180	21.210	21.250	21.300

Löffelspatel, mit flachem Löffel, Rundstiel, Remanit 4301

Spoon and spatula, with flat spoon, rod handle, 18/10



Länge / length mm	120	150	180	210	230
	235.128	235.158	235.188	235.218	235.230

Offener Löffel, Rundstiel, Remanit 4301

Open spoon, rod handle, 18/10



Länge / length mm	200
	26.200

Apothekerlöffel, Standard, Remanit 4301

Chemists spoon, standard, 18/10



Länge / length mm	150
	28.150

Apothekerlöffel, breite Form, Remanit 4301

Chemists spoons with wide ends, 18/10



Länge / length mm	150	200	240	280	320
	27.150	27.200	27.240	27.280	27.320

Chemikalienlöffel, einseitig, Rundstiel, Remanit 4301

Chemical spoons, single spoon, rod handle, 18/10



Länge / length mm	120	150	180	210	250	300
	24.120	24.150	24.180	24.210	24.250	24.300

Chemikalienlöffel, doppelt, Rundstiel, Remanit 4301

Chemical spoons, double spoon, rod handle, 18/10



Länge / length mm	120	150	180	210	250	300
	23.120	23.150	23.180	23.210	23.250	23.300

Chemikalienlöffel, vorn offen, Rundstiel, Remanit 4301

Chemical spoons, one open end, rod handle, 18/10



Länge / length mm	150	180	210
	326.150	326.180	326.210

Löffelspatel mit Rundstiel, Remanit 4301

Spoon spatulas with rod handle, 18/10



Länge / length mm	150	180	210	250
	210.150	210.180	210.210	210.250

**Mehrzwecklöffel, Rundstiel Ø = 5 mm,
Löffel: 15 x 35 mm, Remanit 4301**

General purpose spoon and spatula, rod handle, Ø 5 mm,
spoon: 15 x 35 mm, 18/10



29.150



329.150

Länge / length mm	150	180	210	250	300
Rechtshänder / right-handed	29.150	29.180	29.210	29.250	29.300
Linkshänder / left-handed	329.150	329.180	329.210		

**Mehrzwecklöffel, Rundstiel Ø = 8 mm,
Löffel: 28 x 65 mm, Remanit 4301**

General purpose spoon and spatula, rod handle, Ø 8 mm,
spoon: 28 x 65 mm, 18/10



29.218



329.218

Länge / length mm	210	250	300	400	500
Rechtshänder / right-handed	29.218	29.258	29.308	29.408	29.508
Linkshänder / left-handed	329.218	329.258	329.308		

Probenlöffel mit Einfüllrinne, Remanit 4301

Spoon and spatula with filling-channel, 18/10



Länge / length mm	190
	29.190

**Schnittfänger, Remanit 4301, flexible Klinge,
Klinglänge 50 mm, Edelstahlgriff**

Spatulas with extremely flexible blade and stainless steel handle,
length of blade: 50 mm, 18/10



Gesamtlänge / total length mm	150	150	150
Breite / width mm	10	15	20
	83.010	83.015	83.020

**Schnittfänger, Remanit 4301, flexible Klinge,
Klinglänge 50 mm, Griff aus Pressholz**

Spatulas with extremely flexible blade and riveted
wood handle, length of blade: 50 mm, 18/10



Gesamtlänge / total length mm	150	150	150
Breite / width mm	10	15	20
	63.010	63.015	63.020

**Apothekerspatel, extrem flexible Klinge,
Chromstahl gehärtet**

Spatulas with extremely flexible blade,
chromium steel, hardened



Klinglänge / blade length mm	75	100	130	150
Klingenbreite / blade width mm	18	20	20	22
Mit Holzgriff / wooden handle	861.075	861.100	861.130	861.150
Mit Kunststoffgriff, spülmaschinenfest / plastic handle, dishwasher-safe	851.075	851.100	851.130	851.150

**Apothekerspatel, Klinge Edelstahl, Holzgriff,
75 bis 150 mm: konische Klingen**

*Spatulas, stainless steel blade, wooden handle,
75 – 150 mm: conical blade*



Klingenlänge / blade length mm	75	100	130	150	200	250	300
Klingenbreite / blade width mm	18/22	18/22	18/22	18/22	30	30	30
Remanit 4310, flexibel / INOX 4310, flexible	61.075	61.100	61.130	61.150			
Chromstahl 1.4034, gehärtet / INOX 4034, hardened	661.075	661.100	661.130	661.150	661.200	661.250	661.300

**Apothekerspatel, Klinge aus Edelstahl, mit Kunststoffgriff,
konische Klingen, spülmaschinenfest**

*Spatulas, stainless steel blade, plastic handle,
conical blades, dishwasher-safe*



Klingenlänge / blade length mm	75	100	130	150
Klingenbreite / blade width mm	18/22	18/22	18/22	18/22
Remanit 4310, flexibel / INOX 4310, flexible	51.075	51.100	51.130	51.150
Chromstahl 1.4034, gehärtet / INOX 4034, hardened	651.075	651.100	651.130	651.150

**Stativplatten, Remanit 4301, mit Gewinde M 10,
mit 4 verstellbaren Füßen**

Retort stands with M 10 thread, with 4 adjustable feet, 18/10



Länge / length mm	180	220	250	285	315	330
Breite / width mm	100	142	142	142	200	165
Gewicht / weight g	850	1470	1670	1900	2970	2600
	459.180	459.220	459.250	459.285	459.315	459.330

Stativplatten, Remanit 4301, mit Gewinde M 10

Retort stands with M 10 thread, 18/10

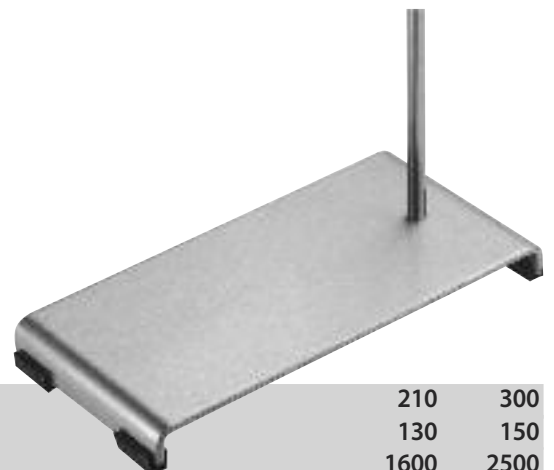

Länge / length mm	210	300
Breite / width mm	130	150
Gewicht / weight g	1600	2500
	450.101	450.301

**Präparierbesteck, 6-teilig gefüllt,
alle Teile ganz aus Edelstahl, in Tasche**

*Dissecting set in plastic sheath, 6 pcs.,
all articles made of stainless steel*

Tasche 6-teilig / set 6 pcs.	66.906
Tasche 12-teilig / set 12 pcs.*	66.912



Inhalt	Contents
1 Löffelspatel, 150 mm	1 spoon spatula, 150 mm
1 Pinzette spitz, 130 mm	1 pointed tweezer, 130 mm
1 Pulverspatel, 150 / 9 mm	1 powder spatula, 150 / 9 mm
1 Skalpell, 125 mm	1 scalpel, 125 mm
1 Schere gerade, 100 mm	1 scissors straight, 100 mm
1 Schnittfänger massiv, 150 mm	1 spatula with blade, 150 mm

* Die Zusammenstellung der 12-teiligen Tasche kann individuell gestaltet werden (auf Anfrage).

* On demand the arrangement of the 12 pcs. set can be individualized.

**Spatelsortiment, 7-teilig gefüllt, Remanit 4301,
in Kunstledertasche mit Klettverschluss**

Spatula set, 7 pcs., in sheath (leather substitute), 18/10

Inhalt	Contents
1 Pinzette stumpf gerade, 145 mm	1 Tweezer, blunt, straight, 145 mm
1 Mikro-Löffelspatel, 150/5 mm	1 Micro spoon spatula, 150/5 mm
1 Mikro-Löffelspatel, 150/7mm	1 Micro spoon spatula, 150/7mm
1 Doppelspatel, 150/9 mm	1 Double spatula, 150/9 mm
1 Pulverspatel, 150/9 mm	1 Powder spatula, 150/9 mm
1 Mikro-Pulverspatel, 150/4 mm	1 Micro powder spatula, 150/4 mm
1 Mikro-Doppelspatel, 150/4 mm	1 Micro double spatula, 150/4 mm
	000.105



**Chemikerbesteck, 4-teilig gefüllt, Remanit 4301,
in Kunstledertasche mit Klettverschluss**

Chemists set, 4 pcs., in sheath (leather substitute), 18/10

Inhalt	Contents
1 Pinzette spitz gerade, 130 mm	1 Tweezer, pointed, straight, 130 mm
1 Schere spitz/stumpf, 130 mm	1 Scissors, pointed/blunt, 130 mm
1 Mikro-Pulverspatel 130/4 mm	1 Micro powder spatula, 130/4 mm
1 Pulverspatel, 150/9 mm	1 Powder spatula, 150/9 mm
	000.110

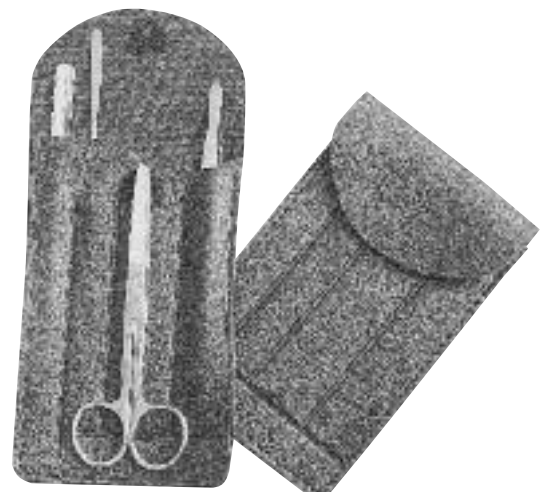

**Mikroskopierbesteck, 6-teilig gefüllt, Remanit 4301,
in Ledertasche mit Reißverschluss**

Microscopy set, 6 pcs., 18/10, in leather sheath with zipper



Inhalt	Contents
1 Skalpell spitz, 160 mm, Schneide 40 mm	1 scalpel pointed, 160 mm, blade 40 mm
1 Schnittfänger, 150 mm, Breite 10 mm	1 spatula, 150 mm, width 10 mm
1 Pinzette spitz gerade, 105 mm	1 tweezer pointed, straight, 105 mm
1 Mikroskopierschere gerade, 100 mm	1 microscopy scissors straight, 100 mm
1 Präpariernadel gerade mit Kunststoffgriff, 140 mm	1 needle straight, with plastic handle, 140 mm
1 Lanzette mit Kunststoffgriff, 140 mm	1 lance with plastic handle, 140 mm

67.006

**Mikroskopierbesteck, 9-teilig gefüllt, Remanit 4301,
in Ledertasche mit Reißverschluss**

Microscopy set, 9 pcs., 18/10, in leather sheath with zipper



Inhalt	Contents
1 Skalpell spitz, 160 mm, Schneide 40 mm	1 scalpel pointed, 160 mm, blade 40 mm
1 Schnittfänger, 150 mm, Breite 10 mm	1 spatula, 150 mm, width 10 mm
1 Pinzette spitz gerade, 105 mm	1 tweezer pointed, straight, 105 mm
1 Mikroskopierschere gerade, 100 mm	1 microscopy scissors, straight, 100 mm
1 Mikroskopierschere gebogen, 100 mm	1 microscopy scissors, curved, 100 mm
1 Präpariernadel gerade mit Kunststoffgriff, 140 mm	1 needle straight with plastic handle, 140 mm
1 Präpariernadel gebogen mit Kunststoffgriff, 140 mm	1 needle curved with plastic handle, 140 mm
1 Lanzette mit Kunststoffgriff, 140 mm	1 lance with plastic handle, 140 mm
1 Rasiermesser, ausklappbar, mit Kunststoffgriff	1 razor with blade and plastic handle

67.009

Anatomisches Besteck, 13-teilig gefüllt, Remanit 4301, in Ledertasche mit Reißverschluss

Dissecting set, 13 pcs., 18/10, in leather sheath with zipper



Inhalt	Contents
1 Skalpell spitz, 160 mm, Schneide 40 mm	1 scalpel pointed, 160 mm, blade 40 mm
1 Skalpell spitz, 130 mm, Schneide 17 mm	1 scalpel pointed, 130 mm, blade 17 mm
1 Skalpell ballig, 130 mm, Schneide 17 mm	1 scalpel round, 130 mm, blade 17 mm
1 Schnittfänger, 150 mm, Breite 10 mm	1 spatula 150 mm, width 10 mm
1 Pinzette spitz gerade, 105 mm	1 tweezer pointed, straight, 105 mm
1 Pinzette stumpf gerade, 115 mm	1 tweezer blunt, straight, 115 mm
1 Mikroskopierschere gerade, 100 mm	1 microscopy scissors, straight, 100 mm
1 Mikroskopierschere gebogen, 100 mm	1 microscopy scissors, curved, 100 mm
1 Verbandsschere, spitz / stumpf, 130 mm	1 bandage scissors pointed / blunt, 130 mm
1 Richtsonde, 150 mm	1 director, 150 mm
1 Präpariernadel gerade mit Kunststoffgriff, 140 mm	1 needle straight with plastic handle, 140 mm
1 Präpariernadel gebogen mit Kunststoffgriff, 140 mm	1 needle curved with plastic handle, 140 mm
1 Lanzette mit Kunststoffgriff, 140 mm	1 lance with plastic handle, 140 mm
	67.013

Mikroskopierbesteck, 5-tlg. gefüllt, alle Teile aus Edelstahl, im Holzkasten

Microscopy set in a wooden box, 5 pcs., all articles made of stainless steel



Kasten 5-teilig / box 5 pcs.	66.805
Kasten 7-teilig / box 7 pcs.*	66.807

Inhalt	Contents	
1 Mikroskopierschere	1 microscopy scissors	101.100
1 Präpariernadel gerade	1 microscopy needle straight	84.150
1 Präpariernadel gebogen	1 microscopy needle bent	85.150
1 Pinzette, spitz gerade, mit Führungsstift	1 tweezer, pointed straight with guide pin	311.115
1 Skalpell	1 scalpel	66.601

* Die Zusammenstellung des 7-teiligen Bestecks kann individuell gestaltet werden (auf Anfrage).

* On demand the arrangement of the 7 pcs. set can be individualized.

Polierte Stativstäbe, Remanit 4301

Polished support rods, 18/10



Stabdurchmesser / rod diameter mm	12	12	12	12	12	12	12
Stablänge / rod length mm	450	500	600	750	1000	1250	1500
Gewinde M 10 / thread M 10	240.204	240.205	240.206	240.207	240.208	240.209	240.210
Ohne Gewinde / without thread	241.204	241.205	241.206	241.207	241.208	241.209	241.210

DreifüÙe, Remanit 4301, zerlegbar, 210 mm hoch

Tripods, ring plus detachable legs, 210 mm high, 18/10



Ring-Durchmesser innen / inner ring diameter mm	100	120	140	160	180
	493.100	493.120	493.140	493.160	493.180

Verlängerungen für DreifüÙe bis zur Gesamthöhe von 370 mm

Extension legs, total height 370 mm

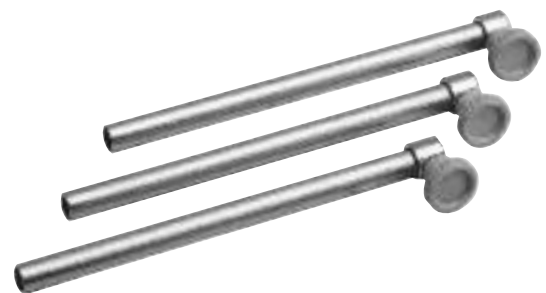

Satz à 3 Stück / set of three legs	497.370
------------------------------------	---------

Klemmen, stabile Lappenschraube, Remanit 4301, mit Kork ausgelegt

Clamps, stable clamp screw, cork protection on clamp, 18/10

Clamps, stable clamp screw, cork protection on clamp, 18/10



Spannweite / inside clamp mm	25	40	60
	450.625	450.640	450.660

Klemmen mit Muffe, Remanit 4301, stabile Lappenschrauben, mit Kork ausgelegt

Clamps with sleeve, stable clamp screws, cork protection on clamp, 18/10

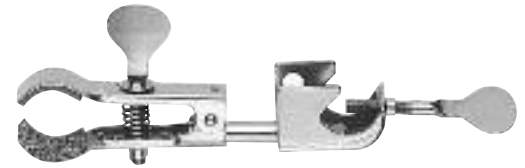

Spannweite / inside clamp mm	25	40	60
	451.625	451.640	451.660

Bürettenklemme, Remanit 4301

Burette clamp, 18/10



Einfach mit Stab / single with rod	456.000
---	---------

Universalklemme, Remanit 4301, 4-Finger-Backen, mit Kork ausgelegt, Spannweite 0-90 mm

All purpose clamp, 4-finger clamps, cork protection on clamp, inside clamp 0-90 mm, 18/10

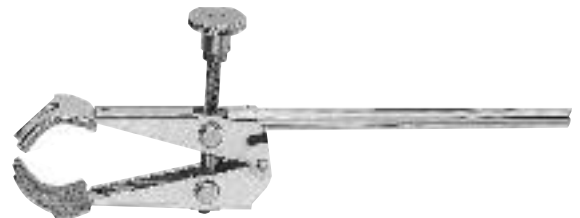

	470.000
--	---------

Universalklemme, Zinkdruckguss, 4-Finger-Backen, mit Kork ausgelegt

All purpose clamp, zinc die casting, 4-finger clamps, cork protection on clamp

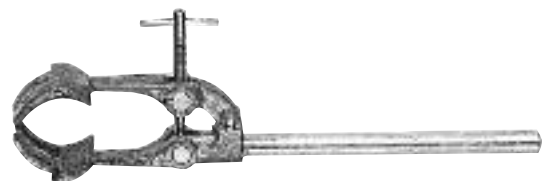

Spannweite / inside clamp mm	90
unlackiert / natural alloy	400.000

Doppelmuffe, Remanit 4301, stabile Lappenschrauben

Double socket, stable clamp screws, 18/10

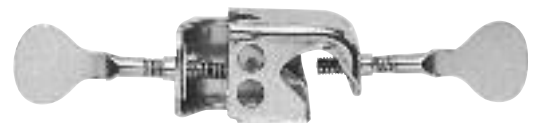

Spannweite / inside clamp mm	13
	450.000

Schwere Stativringe, Remanit 4301, Stabstahl 8 mm

Heavy support rings, rod 8 mm, 18/10

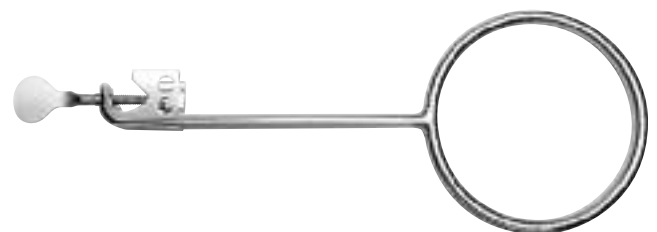

Innendurchmesser / inner diameter mm	50	70	100	130	160
Mit Stab / rod only	280.050	280.070	280.100	280.130	280.160
Mit Muffe / with clamp	281.050	281.070	281.100	281.130	281.160
Mit Stab, vorn offen, Gummiüberzug / rod, open, with rubber coating	283.050	283.070	283.100	283.130	283.160
Mit Muffe, vorn offen, Gummiüberzug / clamp, open, with rubber coating	284.050	284.070	284.100	284.130	284.160

**Drahtgewebe mit Rahmen, ganz aus Edelstahl,
Maschen: 0,6 x 2,0 mm,
feinmaschiges Zentrum: hitzebeständiger Edelstahl**

*Woven wire with frame, mesh 0.6 x 2.0 mm,
fine meshed centre, heat resistant – high grade stainless steel*

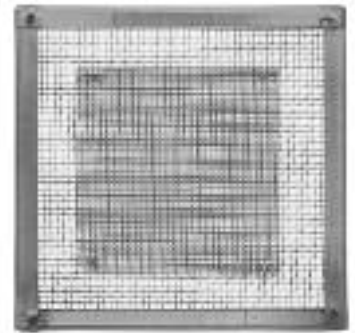

mm x mm	135	155	175	195
	247.935	247.955	247.975	247.995

**Drahtgewebe aus Edelstahldraht, mit umgelegten Kanten,
Maschen: 0,6 x 2,0 mm**

*Woven wire, with reversed borders,
mesh: 0.6 x 2.0 mm, stainless steel*

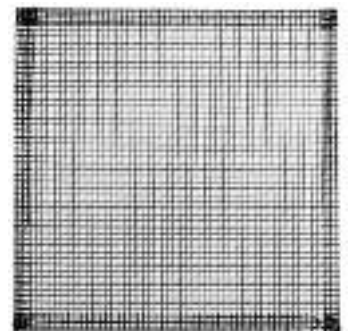

mm x mm	115	135	155	175	195
	247.815	247.835	247.855	247.875	247.895

Draht-Dreiecke, Remanit 4301, mit Quarz-Rohren

Wire triangles with quartz tubes, 18/10

Schenkel-Länge / side length mm	40	50	60	70
	257.404	257.405	257.406	257.407

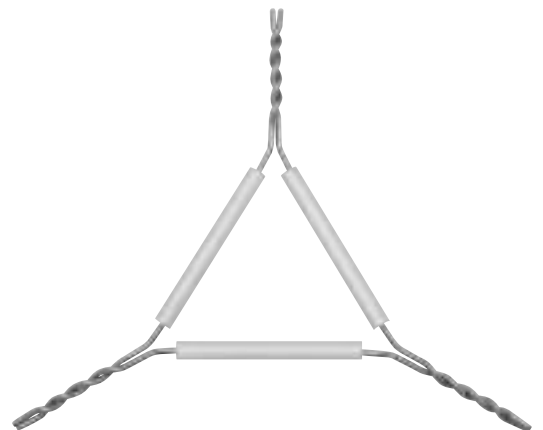

**Rasiermesser mit Kunststoffgriff,
lange, auswechselbare Klinge,
incl. 10 Ersatzklingen**

*Razor with plastic handle, long exchangeable
blade, incl. 10 additional razor blades*

	66.071
--	--------



**Rasiermesser mit Metallgriff,
lange, auswechselbare Klinge,
incl. 10 Ersatzklingen**

*Razor with metal handle, long exchangeable
blade, incl. 10 additional razor blades*

	66.072
--	--------



10 Stk. Ersatzklingen für 66.071 und 66.072
10 pcs. razor blades for articles 66.071 and 66.072



	66.073
--	--------

Anatomisches Skalpell, Chromstahl 1.4034
Dissecting scalpel, INOX 4034



Länge / length mm	125
	66.601

Skalpelle, Chromstahl 1.4021
Scalpels, INOX 4021



Länge / length mm	125
ballig / round	66.610
spitz / pointed	66.620



Präpariernadeln, Remanit 4301
Dissecting needles, 18/10



Mit Kunststoffgriff / with plastic handle	
gerade / straight	64.140
gebogen / curved	65.140
Lanzette / lance	66.140



Mit Naturholzgriff / with wooden handle	
gerade / straight	64.141
gebogen / curved	65.141



Präpariernadeln, Edelstahlgriff, Remanit 4301
Dissecting needles, stainless steel handle, 18/10



gerade / straight	84.150
gebogen / curved	85.150
Lanzette / lance	86.150



Nadelhalter nach Kolve
Needleholders for attachments below



Länge / length mm	170	240
	267.417	267.424

**Abstrichösen, hitzebeständiger Heizleiterdraht,
Lanzetten und Nadeln:
Draht-Durchmesser 0,6 mm**

*Loops, resistance wire, heat resistant, lances and needles:
wire diameter 0,6 mm*

Länge / length mm	Durchmesser / diameter mm		
	1,5	2,5	4,0
50	268.001	268.002	268.003
75	268.011	268.012	268.013

Länge / length mm	50
Lanzette / lance	268.004
Nadel / needle	268.005



268.001, 268.011

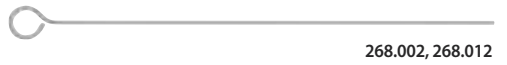

268.002, 268.012



268.003, 268.013



268.004



268.005

Glasschneidmesser, Hartmetall mit Holzgriff

Glass cutter knife, carbide with wooden handle



Glasschneidmesser, komplett / glass cutter knife, complete	267.100
Ersatzklinge 40 x 20 x 1,5 mm / replacement blade 40 x 20 x 1.5 mm	267.101

Glasschreiber, Hartmetall, im Druckstift

Glass engraver, carbide, in holder



Glasschreiber komplett / complete engraver	104.138
Nadel / needle	104.038

**Hand-Korkbohrer, hartgezogene Messingrohre,
hochglanzvernickelt, mit Ausstoßer**

Hand corkborers, nickel plated, with ejector



Anzahl / quantity	3	6	9	12	15	18
Durchmesser / diameter mm	5-7,5	5-11	5-15	5-18,5	5-22	5-26
	260.003	260.006	260.009	260.012	260.015	260.018

Korkbohrer-Schärfer für Bohrer 3-18

Cork borer sharpener for borers 3-18



266.200

Schraubhähne nach Hoffmann, mit Klappe, Messing vernickelt

Tube clamps, brass, nickel plated, with flap

Abstand zwischen den Stangen / length mm	20	25	30	40
	262.720	262.725	262.730	262.740



Quetschhähne nach Mohr, Messing vernickelt

Tube clamps, brass, nickel plated

Länge / length mm	50	60	70	80
	262.550	262.560	262.570	262.580



Skalpellhalter, Stahl verchromt

Scalpel handle, steel chromium plated



106.621



je 10 Klingen, passend für Skalpellhalter 106.621 / pack of 10 blades, fits to scalpel handle 106.621

106.180 106.190 106.200 106.210 106.220 106.230 106.250 106.255 106.360

Skalpellhalter, Stahl verchromt

Scalpel handle, steel chromium plated



106.523



je 10 Klingen, passend für Skalpellhalter 106.523 / pack of 10 blades, fits to scalpel handle 106.523

106.100 106.105 106.110 106.120 106.130 106.140 106.150 106.160 106.170

Allerschneider, mit Kunststoffgriff

Sturdy scissors, plastic covered handles

Länge / length mm	180
	109.185



Universalscheren, eisgehärtet, Edelstahl rostfrei, mit Kunststoffgriff

General purpose ice-tempered scissors, stainless steel, plastic covered handles

Länge / length mm	150	210
	109.160	109.200



Verbandscheren, Chromstahl 1.4021

Bandage scissors, INOX 4021

Länge / length mm	130	145	160
spitz / stumpf – pointed / blunt	103.130	103.145	103.160
spitz / spitz – pointed / pointed	105.130	105.145	105.160
stumpf / stumpf – blunt / blunt	107.130	107.145	107.160



Mikroskopierscheren, warm geschmiedet

Microscopy scissors, warm forged

Länge / length mm	90	100
gerade / straight	101.090	101.100
gebogen / curved	101.091	101.101



Papierscheren, warm geschmiedet

Paper scissors, warm forged

Länge / length mm	160	180	225	250
	101.160	101.180	101.225	101.250



Verbandschere spitz / stumpf, warm geschmiedet

Bandage scissors, pointed / blunt, warm forged,

Länge / length mm	130
	101.130



Verbandschere stumpf, Edelstahl, schlagfester Kunststoffgriff

Bandage scissors, blunt, stainless steel, plastic covered handles, impact-resistant

Länge / length mm	130
	101.131



Laborschere, sehr fein, Edelstahl, schlagfester Kunststoffgriff

Laboratory scissors, very fine, stainless steel, plastic covered handles, impact-resistant

Länge / length mm	90
	101.092



Hobbyschere, Edelstahl, großer schlagfester Kunststoffgriff

Hobby scissors, stainless steel, large plastic covered handles, impact-resistant

Länge / length mm	170
	109.170



Drahtkörbe, Remanit 4301, poliert

Drahtstärke: Rahmen 4 mm
Gewebe 1 mm

Maschenweite: 8 mm

Wire baskets, 18/10, polished

wire: frame 4 mm
wire 1 mm

mesh: 8 mm

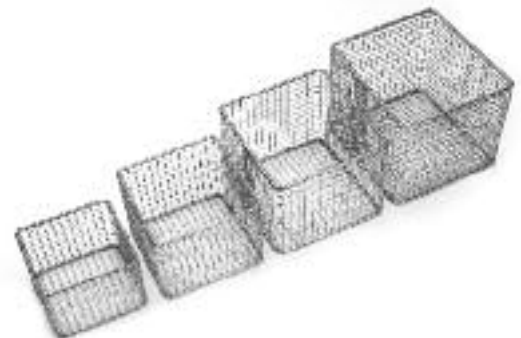

Länge / length mm	100	120	140	160	180	200	300	400
Breite / width mm	100	120	140	160	180	200	200	200
Höhe / height mm	100	120	140	160	180	200	200	200
	120.010	120.012	120.014	120.016	120.018	120.020	120.030	120.040

Instrumentenschalen, Remanit 4301

Rectangular trays for instruments, 18/10

Länge / length mm	Breite / width mm	Höhe / height mm	
170	110	20	701.217
200	120	20	701.220
220	140	28	701.222
240	180	30	701.224
260	180	30	701.226
280	180	30	701.228
310	210	40	701.230
350	250	40	701.235
420	280	50	701.242
520	340	50	701.252



Schalen mit Rand, Remanit 4301

Bowls with rim, 18/10



Inhalt / volume ml	200	400	1000	2000	3000	4000	5000	6000	8000	11000
Höhe / height mm	65	45	90	115	120	120	135	135	160	180
Durchmesser / diameter mm	105	155	175	217	245	286	315	320	350	395
	705.100	705.150	705.180	705.240	705.260	705.270	705.300	705.330	705.360	705.410

Abdampfschalen, Remanit 4301

Evaporating dishes, 18/10



Inhalt / volume ml	60	100	175	400
Höhe / height mm	25	25	25	25
Durchmesser / diameter mm	60	75	100	150
	870.060	870.070	870.100	870.150

Chemikalienschaufeln, Remanit 4301

Chemical scoops, 18/10



Inhalt / volume cm ³	120	450	1000	1500	2500
Durchmesser / diameter mm	50	75	100	120	150
Schaufellänge / scoop length mm	100	150	200	240	250
Grifflänge / handle length mm	90	100	110	110	115
	758.050	758.075	758.100	758.120	758.150

Chemikalienschaufeln aus Aluminium

Chemical scoops, aluminium

Länge / length mm	Volumen / volume g	
160	70	748.160
185	90	748.185
210	130	748.210
250	250	748.250
265	285	748.265
290	375	748.290
310	450	748.310
350	800	748.350
400	1500	748.400
430	2500	748.430



Eimer, Remanit 4301, graduiert, mit glattem Boden

Buckets, graduated, with smooth bottom, 18/10

Inhalt / volume l	6	10	12	15
Eimer / buckets	730.006	730.010	730.012	730.015
Deckel / cover for buckets	731.006	731.010	731.012	731.015



Messbecher mit Griff, Remanit 4301

Graduated jugs with handle, 18/10

Inhalt / volume ml	250	500	1000	1500	2000
Höhe / height mm	75	110	135	155	180
Durchmesser / diameter mm	95	115	140	155	160
	717.025*	717.050	717.100	717.150	717.200



*ohne Griff / without handle

Graduierte Messuren, Remanit 4301, schwere Ausführung

Graduated jugs with lip and handle, heavy version, 18/10

Inhalt / volume ml	1000	1500	2000
Höhe / height mm	140	170	170
Durchmesser / diameter mm	100	110	130
	718.100	718.150	718.200



Trichter mit Griff und Luftrille, Remanit 4301

Funnels with handle and air channel, 18/10

Höhe / height mm	90	115	125	145	190	220	260
Durchmesser / diameter mm	50	80	100	120	150	200	250
	785.050	* 785.080	* 785.100	785.120	785.150	785.200	785.250

* ohne Griff / without handle



Sandbad-Schalen mit flachem Boden, Remanit 4301

Round bowls, flat bottom, 18/10



Inhalt / volume ml	20	35	60	85	125	250	500	1000	2000	5000
Höhe / height mm	20	25	30	35	40	50	60	80	100	120
Durchmesser / diameter mm	40	50	60	70	80	100	120	160	200	250
	74.020	74.035	74.060	74.085	74.125	74.250	74.500	74.001	74.002	74.005

Kristallier-Schalen, hohe Form, Remanit 4301

Bowls, deep form, 18/10



Inhalt / volume ml	500	1000	2000	5000
Höhe / height mm	55	70	105	160
Durchmesser / diameter mm	150	140	160	200
	72.500	72.001	72.002	72.005

Becher, Molybdän-legierter Edelstahl, 1.4404

(Besonders geeignet für nichtoxidierende Säuren)

Beakers, molybdenum stainless steel (extra special for non-oxidizing acids)

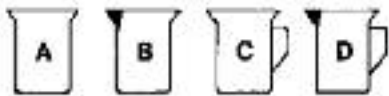

Inhalt / volume ml		100	250	500	1000	2000	3000	5000
Höhe / height mm		65	80	110	130	180	180	210
Durchmesser / diameter mm		55	65	80	100	120	150	180
A Bördelrand, glatt / straight edge		75.100	75.250	75.500	75.001	75.002	75.003	75.005
B Mit Ausguss / with lip		70.100	70.250	70.500	70.001	70.002	70.003	70.005
C Glatter Bördelrand mit Henkel / straight edge with handle		78.100	78.250	78.500	78.001	78.002	78.003	78.005
D Mit Ausguss und Henkel / with lip and handle		77.100	77.250	77.500	77.001	77.002	77.003	77.005

Sicherheits-Schneidergerät mit auswechselbarer Klinge, beim Ablegen des Gerätes zieht eine Feder die Klinge automatisch zurück. GS-geprüft.

Safety cutting knife with removable blade. After using and depositing the blade is automatically retracted into the handle. GS-tested.



Schneidergerät / cutting knife	102.152
je 5 Ersatzklingen / 5 replacement blades	102.052

Sicherheits-Korkschneidmesser, stabile abgerundete Klinge, Reduzierung der Verletzungsgefahr durch Sicherheits-Kunststoffgriff.

Safety cork cutting knife, with stable rounded blade, risc of injury is reduced by safety plastic handle.



Länge / length mm	225
Klingenlänge / blade length mm	90
	266.225

Keramikkmesser

Bruchstabilisiert, säurebeständig, korrosionsfrei, sehr leicht, antimagnetisch, spülmaschinenfest

ACHTUNG: Sehr scharf!

Ceramic knives

Break and acid proof, corrosion resistant, low weight antimagnetic, dishwasher safe

NOTE: Very sharp!

Klingenlänge / blade length mm	90	90	120	150
	199.001	199.002	199.003	199.004



RSG-Labormesser der Serie „Profi“

Chrom-Molybdän-Vanadium-Stahl, geschmiedet, eisgehärtet, Handabzug, POM-Kunststoffgriff, verschiedene Klingen für unterschiedliche Anwendungen.

ACHTUNG: Sehr scharf!

RSG laboratory knives, "Profi" series

Chromium molybdenum vanadium steel, forged, ice-tempered, hand sharpened, POM-handles, different blades for variable use.

NOTE: Very sharp!

Klingenlänge / blade length mm	90	120	150	200	260	260	140
	192.031	192.033	192.053 *	192.036	192.052	192.042	180.530



* Klinge flexibel / flexible blade

Länge / length mm	260
Wetzstahl / sharpener	181.086

Labormesser

Laboratory knives

Klingenlänge / blade length mm	60	80
Schwarzer Griff, glatte Schneide / black handle, smooth blade	199.006	
Weißer Griff, glatte Schneide / white handle, smooth blade	199.033	
Schwarzer Griff, glatte Schneide / black handle, smooth blade		199.115
Schwarzer Griff, Wellenschliff / black handle, serrated blade		199.049



Gasbrenner nach Bunsen
Gasburners, Bunsen type



	Luftregulierung air regulation	Luftregulierung / Nadelventil air regulation / needle valve
Propangas / propane gas	253.020	253.120
Erdgas / natural gas	253.030	253.130

**Gasbrenner nach Bunsen mit Luftregulierungshülse,
Gasregulierung durch Hahn, mit Sparflamme**
Gasburner Bunsen type with air adjustment sleeve,
gas adjusted by tap, giving economical flame

Propangas / propane gas	253.620
Erdgas / natural gas	253.630



Spiritusbrenner aus Edelstahl
Spirit of wine burner, stainless steel

Inhalt ca. / approx. contents ml	60
Mit Dochtregulierung und Verschlusskappe / with wick regulation and cowl	253.000



Weitere Brenner auf Anfrage / further burners available on request

Reagenzglas-Gestelle, stapelbar, Remanit 4301

Test tube racks, stockable, 18/10

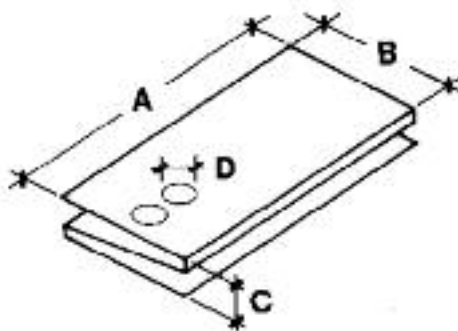

Breite / length mm	A	110	220	220	220	155	188	220	220
Tiefe / width mm	B	110	110	115	115	78	95	115	115
Höhe / height mm	C	40	40	63	63	50	58	63	63
Anzahl Bohrungen / number of holes		25	50	32	15	50	50	50	45
Lochdurchmesser / hole diameter mm	D	17,5	17,5	22	30	12,5	14,5	17,5	19
		117.025	117.050	117.032	117.015	117.051	117.052	117.053	117.054



Solingen

ROSTFREI-SCHNEIDWERKZEUGE GMBH

Chiuso

Postfach 11 08 20 · D-42668 Solingen · Löhdorfer Straße 169 · D-42699 Solingen
Telefon (02 12) 6 40-0 · Fax (02 12) 6 40-50 · Mail info@rsg-solingen.de
www.rsg-solingen.de

P.O.B. 11 08 20 · D-42668 Solingen · Löhdorfer Str. 169 · D-42699 Solingen
Phone +49(0)212 6 40-0 · Fax +49(0)2 12 6 40-50 · mail info@rsg-solingen.de
www.rsg-solingen.de
