

## SECUMAX OPTICUT

**Metal foot**  
to glide across surfaces

**Ergonomic handle**  
for "pull" cutting

**Movable plastic catch**  
for blade changing



**Concealed blade**  
for maximum protection  
of users and goods

**4-cutting edge blade**  
for longer durability

**Plastic material guide**  
to maintain downward  
pressure on the material  
being cut



### USAGE

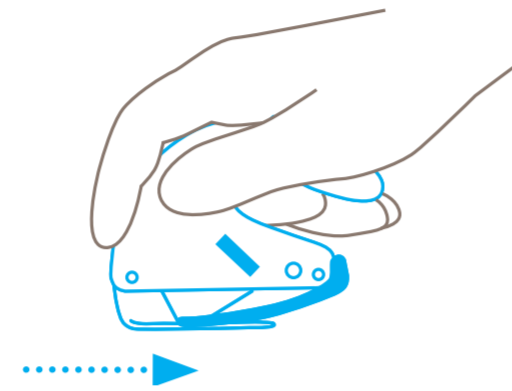

Cut by **pulling** backwards.

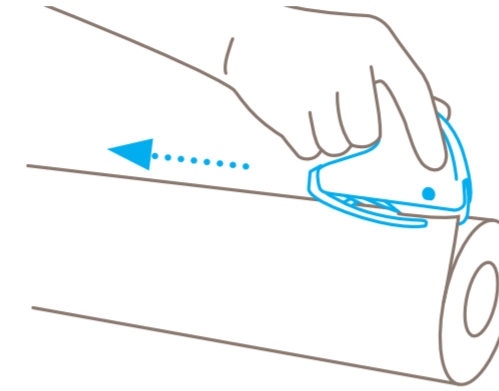

**Pierce** film and paper sheets at the required position using the point of the metal foot.

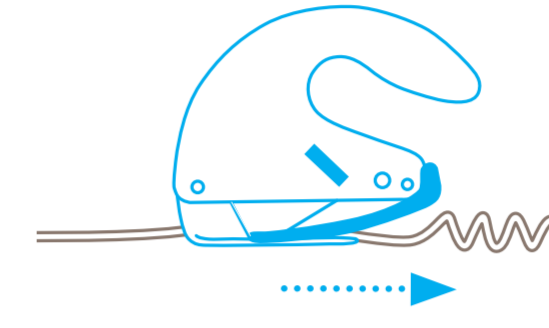

Whether cutting foam or film, the bendable plastic material-guide reliably stops material jamming in front of the blade.

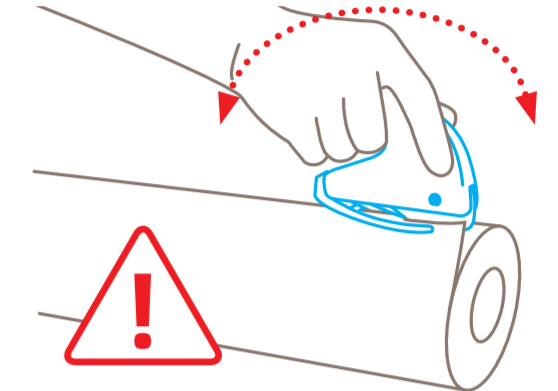

Only cut by sliding. Cutting by levering may break the metal foot.

### BLADE CHANGE



**Lift** the catch and move downwards until its end covers the blade change button.



Press the catch and remove the metal foot from the handle. Replace or reverse the blade.



Press the catch again and insert the metal foot back into the handle until it **clicks**. Check that the foot is correctly inserted.



Move the catch back into the **starting position**.

### PROTECTION OF USER

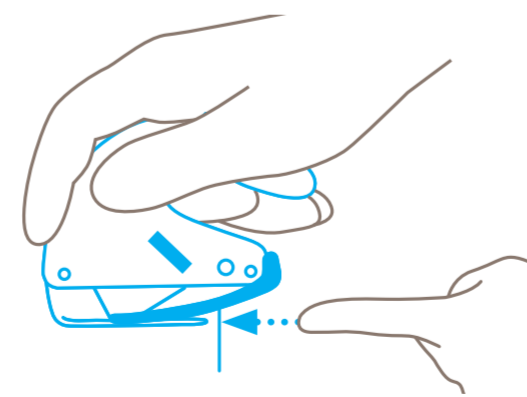

The concealed blade provides a maximum degree of **protection from cut injuries**.

### PROTECTION OF GOODS

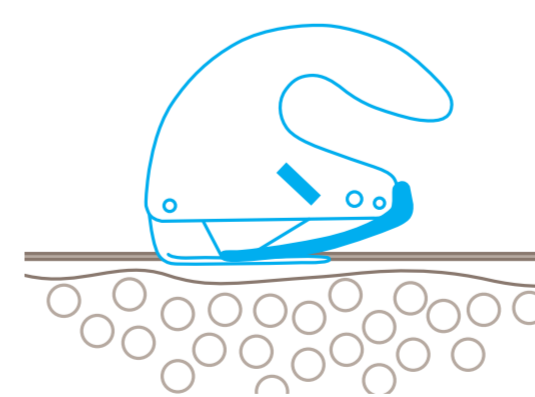

The concealed blade **will not get into contact with your goods** either.

### DISPOSAL

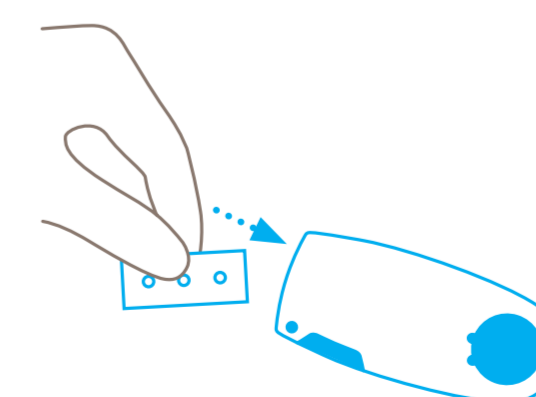

Your **SAFEBOX** is the best place to store **used blades**.

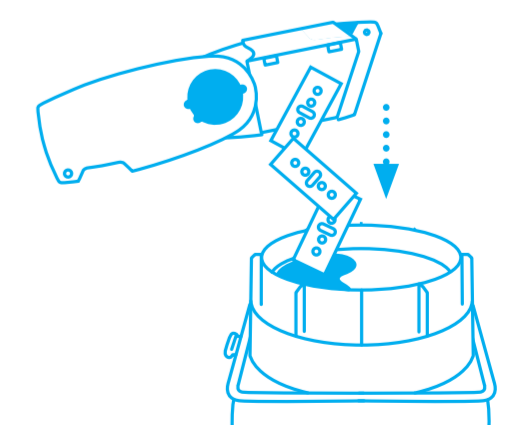

When the **SAFEBOX** is full, **empty all contents** into your **USED BLADE CONTAINER**.

**Please note:** To ensure your product always functions flawlessly, regularly remove any impurities. For additional safety, we recommend wearing gloves.